

All Dimensions Are In mm Unless Stated

**Notes:**

- Minimum 44mm Door Thickness
- 20mm Thick Hardwood Lipping To Leaf Top Edge
- 20mm Thick Stop To Frame Head (Planted On Or Rebated)
- Minimum 32mm Thick Frame Section

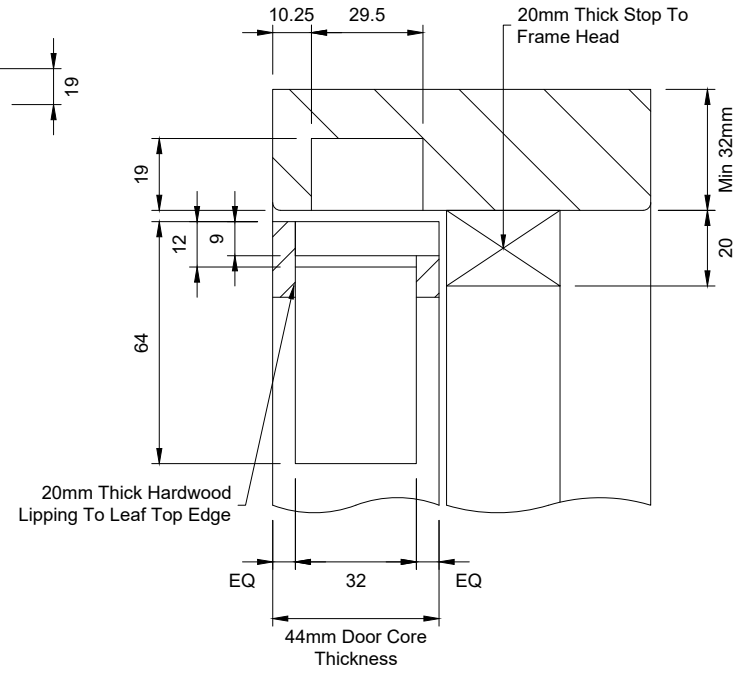
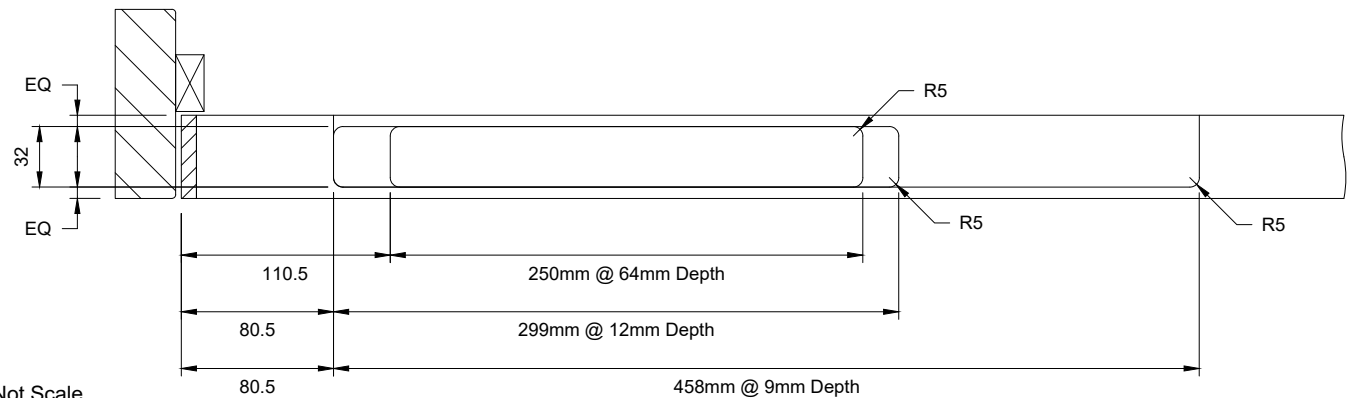
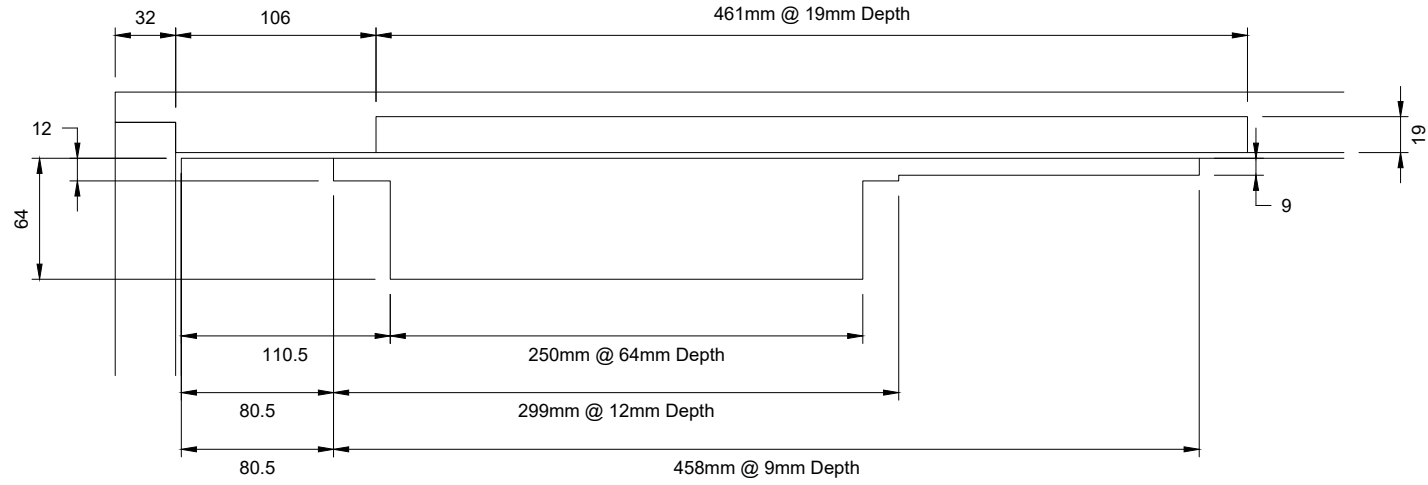
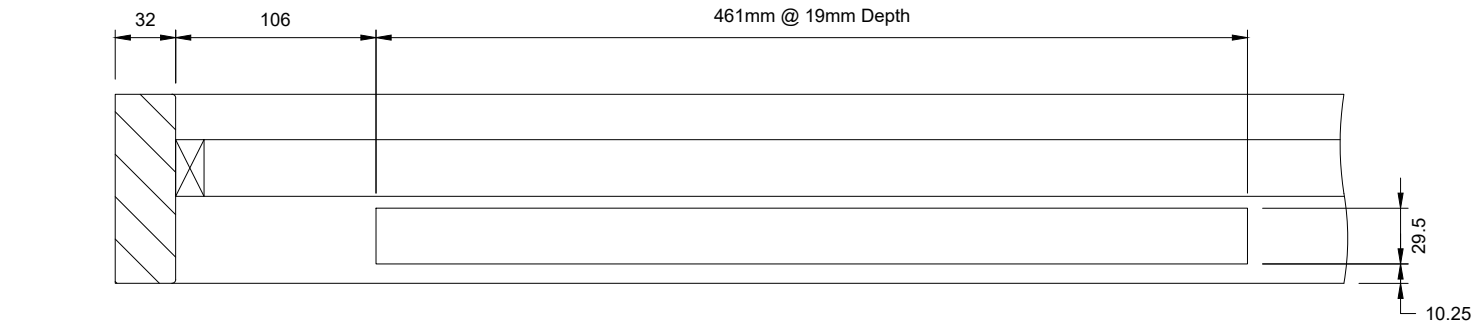

Do Not Scale.

If In Doubt Ask!

Description: **Concealed Closer Machining - NFR - 44mm Core - Rutland ITS.11204 2-4**

Drawn By: **O BOOY**  
 Size: **As Above**  
 Job No: \_\_\_\_\_

Approved: **Approved**  
 Rev: \_\_\_\_\_  
 Tolerance: **±0.25mm**

Date: **22/05/2026**  
 Fire Rating: **NFR**

Cert / FoA Ref: \_\_\_\_\_

Drawing No: **DP25100**  
 Rev00

© Doorpac Ltd  
  
 Unit 6, Ranskill Court,  
 Sheffield,  
 S9 5FZ